



FLUSHMATE®

Genuine Replacement Parts

Effective Date: January 13, 2014



501-B Series
(Discontinued)

504 Series

503 Series

Flushmate® Component Parts

Before starting your repair project, write down the model number, serial number, and Series number located on the Flushmate vessel label inside the toilet tank. Also have handy the name of the manufacturer of the toilet. With this information, you can identify the replacement part you need.

This price sheet is organized by Flushmate Series. Begin with the Series number and move on down to the part that you are looking to replace. A visual representation of the models, assemblies and parts are included inside to help with determining the correct replacement part.



Flushmate Label

Model, Serial and Series numbers found here.

Flushmate products cannot be retrofitted to existing gravity toilet bowls. Please see “Complete Change-Out Kits for Two-Piece Toilets” section for specific change-out information of non-Flushmate pressure toilets.

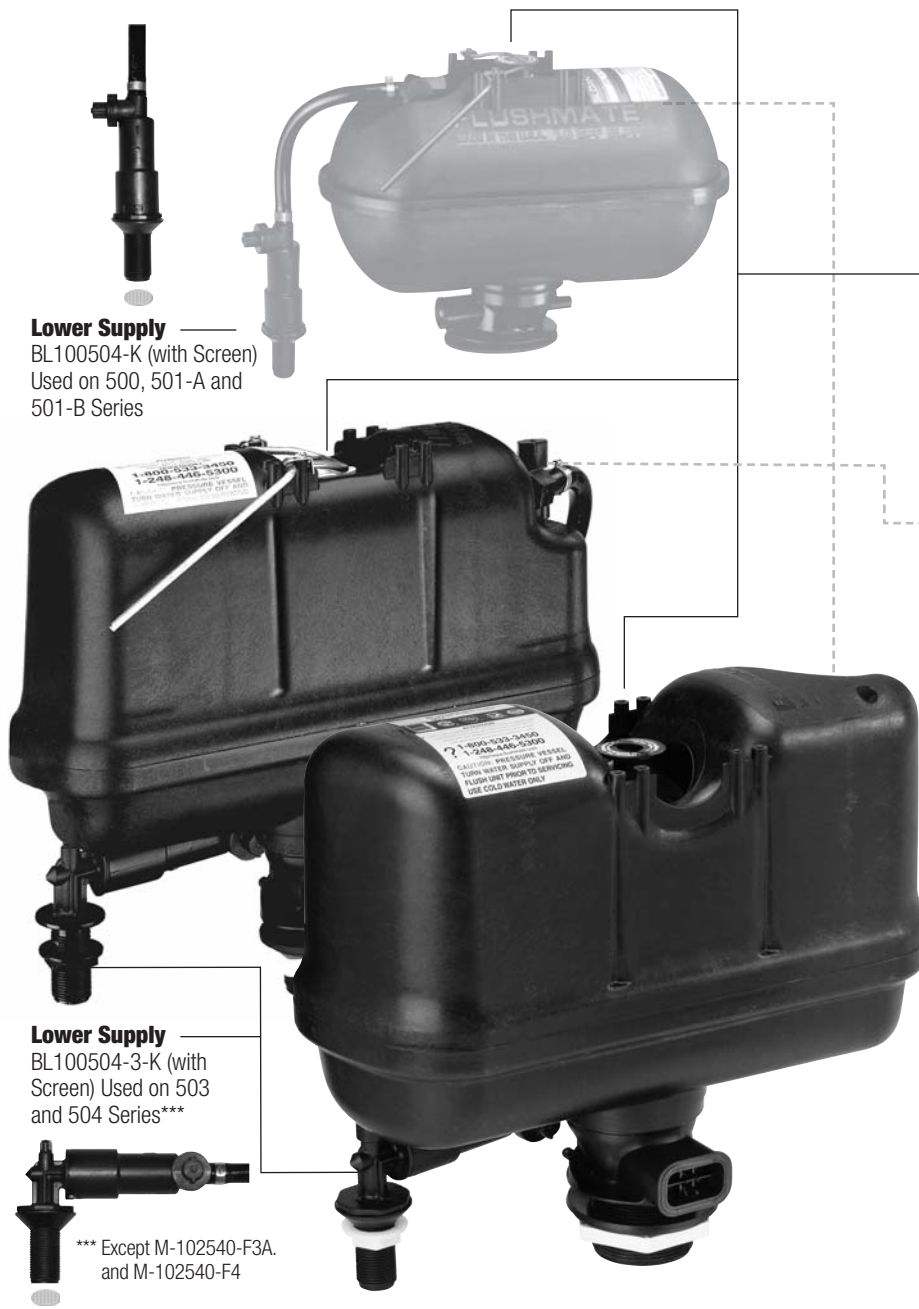

Lower Supply
BL100504-K (with Screen)
Used on 500, 501-A and 501-B Series

Lower Supply
BL100504-3-K (with Screen)
Used on 503 and 504 Series***

*** Except M-102540-F3A.
and M-102540-F4

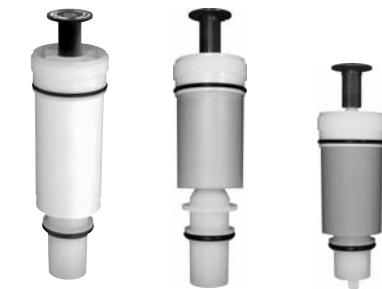

Flush Cartridge
C-100500-K
for 1.6 gpf and 1.0 gpf units. Includes Duckbill and Screen.

Flush Cartridge
C-100501-K
for 1.28 gpf units. Includes Duckbill and Screen.

Flush Cartridge
C-100502-K
Only fits Kohler K-3597 XXXX-C01-XXXX serial number. Includes Duckbill and Screen.

Upper Supply
BU100505-K
Used on all Series

Duckbill Valve
B-108288-BK
Used on all Series
24 pack



Push Button
DP400999-1**
Used on all Series Push Button Models













Universal Tank Bowl Gasket
E-205288
Used on all two piece toilets*



* Except two piece Mansfield toilets
** Replaces DP500999-1

Flushmate Genuine Replacement Parts – Current Models

SERIES	SERIAL NO./STYLE	ORIGINAL	REPLACEMENT	PART NO.	DESCRIPTION	PRICE		
503	MMDDYY-F3†-XXXX 2 piece toilet Flushmate tank configured in a rectangular shape and lower supply is in a right angle from inlet to outlet.			M-101526-F31	Flushmate System 1.6 gpf - For all OEMs except Kohler K4404 tank and Gerber 28-385 tank	107.50		
				M-101526-F32	Flushmate System 1.6 gpf - For Kohler K-4404 tank	107.50		
		M-101526-F33	Flushmate System 1.6 gpf - For Gerber 28-385 tank	107.50				
		M-101526-F3H1	Flushmate System HET 1.28 gpf - For all OEMs except Kohler K4404 tank and Gerber 28-385 tank	115.00				
		M-101526-F3H3	Flushmate System HET 1.28 gpf - For Gerber 28-385 tank	115.00				
		C-100500-K	Flush Cartridge Kit with Duckbill and Screen	26.65				
		C-100501-K	Flush Cartridge 1.28 Kit with Duckbill and Screen	34.45				
		BU100505-K	Upper Supply	7.15				
		BL100504-3-K	Lower Supply	31.30				
		B-108288-BK	Duckbill Valve/Air Inducer - For BU100505-K Upper Supply – 24 pack	14.45				
		AP300503	Handle Replacement Kit - For OEM tanks with Flushmate 503 Series and flush handle	22.50				
		† = Letter of Fixture Manufacturer						
		503	MMDDYY-F3†-XXXX 1 piece toilet Lower supply is either straight or right angle depending on toilet manufacturer. Incorporates bolt plate to attach Flushmate to china.			M-102540-F3	Flushmate System - For Gerber 21-012	112.00
						M-102540-F3A	Flushmate System - For American Standard - push button activated	112.00
C-100500-K	Flush Cartridge Kit with Duckbill and Screen			26.65				
BU100505-K	Upper Supply			7.15				
BL100504-3-K	Lower Supply - For Gerber 21-012			31.30				
BL100504-K	Lower Supply - For American Standard			31.30				
B-108288-BK	Duckbill Valve/Air Inducer - For BU100505-K Upper Supply – 24 pack			14.45				
AP300503	Handle Replacement Kit - For flush handle toilets with a Flushmate 503 Series System			22.50				
† = Letter of Fixture Manufacturer								
COMPLETE CHANGE-OUT KITS FOR TWO PIECE TOILETS								
Complete Change-Out Kit Includes Flushmate System, Mounting Hardware, Installation Wrench, Flush Handle and Owner's Manual						For PF/2 150-404	For EcoFlush B8100 and B8106	
								
						PART NO.	DESCRIPTION	PRICE
						M-101526-F3EK	Flushmate Change-Out Kit - For Eljer tank 141-7000	\$125.00
				M-101526-F3CK	Flushmate Change-Out Kit - For Crane tank 3612	125.00		
				M-101526-F3PK	Flushmate Change-Out Kit - For Peerless tank 1	125.00		
				M-101526-F3ERK	Flushmate Change-Out Kit - For Eljer tank 141-7000, RH	128.00		
				M-101526-F3CRK	Flushmate Change-Out Kit - For Crane tank 3613, RH	128.00		
				M-101526-F3H GK	Flushmate Change-Out Kit HET 1.28 gpf - For Gerber tank DF28-380	132.50		
				M-101526-F3HMK	Flushmate Change-Out Kit HET 1.28 gpf - For Mansfield tank 119	132.50		
				M-101526-F3HCK	Flushmate Change-Out Kit HET 1.28 gpf - For Crane tank 31500 and 31612	132.50		
504	MMDDYY-F4†-XXXX 2 piece toilet Flushmate tank configured in a rectangular shape.			M-101526-F41	Flushmate System, 1.0 gpf - For Vortens/Lamosa 3468 Tank	107.50		
				M-101526-F42	Flushmate System, 1.0 gpf - For Mansfield 153 Tank, St. Thomas/Vitromex Tank, Peerless 1 Tank, Vitra 5066 Tank, Western T4ULF-PF-1 Tank, Corona and Mancesa	107.50		
		M-101526-F43	Flushmate System, 1.0 gpf - For Kohler K4484 tank	107.50				
		C-100500-K	Flush Cartridge Kit with Duckbill and Screen	26.65				
		BU100505-K	Upper Supply	7.15				
		BL100504-3-K	Lower Supply	31.30				
		B-108288-BK	Duckbill Valve/Air Inducer - For BU100505-K Upper Supply – 24 pack	14.45				
		† = Letter of Fixture Manufacturer						
		504	MMDDYY-F4†-XXXX 1 piece toilet Incorporates bolt plate to attach Flushmate to china.			M-102540-FC	Flushmate System - For Kohler K-3597 with Serial No. XXXXXX-FC1-XXXX	123.25
						M-102540-C	Flushmate System - For Kohler K-3597 with Serial No. XXXXXX-C01-XXXX	123.25
				M-102540-F4M	Flushmate System - For Mansfield 704 push button activated, Corona 704 push button activated	112.00		
				C-100500-K	Flush Cartridge Kit with Duckbill and Screen	26.65		
				C-100502-K	Flush Cartridge Kit with Duckbill and Screen. Only fits Kohler K-3597 with XXXXX-C01-XXXX serial number.	34.45		
				BU100505-K	Upper Supply	7.15		
BL100504-K	Lower Supply			31.30				
BL100504-C-K	Lower Supply - For M-102540-C			34.71				
B-108288-BK	Duckbill Valve/Air Inducer - For BU100505-K Upper Supply – 24 pack			14.45				
† = Letter of Fixture Manufacturer								

Flushmate Obsolete Models

200 Series Replacement Systems have been discontinued effective 11/15/2013

Obsolete Series



500

M-101526/M-101525

2 piece toilet. Two hoses attached to Upper Supply.

M-102540

1 piece toilet. Incorporates a bolt plate to attach Flushmate to china.



501

M-101526/M-101525

2 piece toilet. Stainless steel end bells. One hose attached to Upper Supply.

M-102540

1 piece toilet Incorporates a bolt plate to attach Flushmate to china.



501A

M-101526

2 piece toilet

M-102540

1 piece toilet Incorporates a bolt plate to attach Flushmate to china.



501-B

M-101526-F

2 piece toilet tank

M-102540-F

1 piece toilet Incorporates a bolt plate to attach Flushmate to china.

Discontinuation of the Flushmate II, 501-B Series

Effective November 15, 2013 the Flushmate II, 501-B Series will no longer be manufactured. Customers that own a two-piece toilet with a center pushbutton in the lid of the toilet tank will have the option of replacing the discontinued unit (identified below) with the Flushmate III, 503 Series. The replacement unit is part number M-101526-F3B (shown at right), and includes a Flushmate 503 Series System.

Customers with a discontinued unit with a left or right hand flush handle will have the option of replacing their unit with a Flushmate III, 503 Series, part number M-101526-F3BK (shown far right). This part number includes a Flushmate 503 Series System, Handle Replacement Kit and Discharge Nut Wrench.



M-101526-F3B
For 2 piece toilet with center pushbutton in lid of toilet tank



M-101526-F3BK
For 2-piece toilet with left or right flush handle

North America

Manufacturer	Toilet Type	Tank Model #	Center Push-button	Left or Right Flush Handle	Replacement Part #	Price
American Standard	2-pc	4086	Yes		M-101526-F3B	\$107.50
	2-pc	4086		Yes	M-101526-F3BK	130.00
	1-pc	2042	Yes		No Replacement Available	—
	1-pc	2061		Yes	No Replacement Available	—
Briggs	2-pc	4900	Yes		M-101526-F3B	107.50
	1-pc	6090	Yes		No Replacement Available	—
Crane	2-pc	3-615	Yes		M-101526-F3B	107.50
	1-pc	3-600	Yes		No Replacement Available	—
	2-pc	3-616		Yes	M-101526-F3BK	130.00
	2-pc	3-617		Yes	M-101526-F3BK	130.00
Eijer	2-pc	141-7000 (with 501-A and 501-B Series only)		Yes	M-101526-F3B	130.00
Gerber	2-pc	28-390	Yes		M-101526-F3B	107.50
	2-pc	28-390		Yes	M-101526-F3BK	130.00
Kohler	2-pc	4413		Yes	M-101526-F3BK	130.00
Mansfield	2-pc	1	Yes		M-101526-F3B	107.50
	2-pc	1		Yes	M-101526-F3BK	130.00
Orion	2-pc	Turbo-Orion	Yes		M-101526-F3B	107.50
Universal Rundle	2-pc	4462	Yes		M-101526-F3B	107.50
	2-pc	4462		Yes	M-101526-F3BK	130.00

International

Manufacturer	Toilet Type	Tank Model #	Center Push-button	Left or Right Flush Handle	Replacement Part #	Price
Corona	1-pc	30633	Yes		No Replacement Available	—
Laufen	1-pc	na	Yes		No Replacement Available	—

If your toilet tank model is not listed please call Flushmate Consumer Services Department at 800-533-3450.

Flushmate Genuine Replacement Parts – Obsolete Models

SERIES	SERIAL NO./STYLE	PART NO.	DESCRIPTION	PRICE
501-B	MMDDYY-F01-XXXX	C-100500-K	Flush Cartridge Kit with Duckbill and Screen	\$26.65
		BU100505-K	Upper Supply	7.15
501-A	MMDDYY-A01-XXXX	BL100504-K	Lower Supply	31.30
		RK100100	Complete Supply	39.35
		B-108288-BK	Duckbill Valve/Air Inducer - For BU100505-K Upper Supply – 24 pack	14.45
501	C-XXXXXX MMDDYY-111-XXXX	C-100500-K	Flush Cartridge Kit with Duckbill and Screen	26.65
		RK100100	Complete Supply	39.35
500	C-XXXXXX			

Flushmate Genuine Replacement Parts – Other Products

HANDLE/ROD AND ROD KITS

SERIES	PART NO.	DESCRIPTION	PRICE	
503	Handle Replacement Kit	AP300503	Handle Replacement Kit - For flush handle toilets with a Flushmate 503 Series System	22.50
	Two Piece Toilets Handle and Rod Kit	AP300121-L3	Handle/Rod Kit - For American Standard Tank 4098 LH	23.35
		AP300122-R3	Handle/Rod Kit - For American Standard Tank 4098 RH	24.35
		AP300114-L3	Handle/Rod Kit - For Crane Tank 3612 LH	18.12
		AP300115-R3	Handle/Rod Kit - For Crane Tank 3613 RH	19.12
		AP300102-L3	Handle/Rod Kit - For Eljer 141-7000 LH	18.12
		AP300103-R3	Handle/Rod Kit - For Eljer 141-7003 RH	19.12
		AP300104-L32	Handle/Rod Kit - For Gerber Tank 28-380 12" LH	18.12
		AP300105-L30	Handle/Rod Kit - For Gerber Tank 28-385 10" LH	18.12
		AP300106-R3	Handle/Rod Kit - For Gerber Tank 28-380 12" RH	19.12
		AP300107-L3	Handle/Rod Kit - For Mansfield Tank 123 LH	18.12
	AP300109-L3	Handle/Rod Kit - For Orion Tank Turborion II LH	18.12	
	AP300119-L3	Handle/Rod Kit - For Peerless 1, 1.6 gpf LH	18.12	
	AP300100-L3	Handle/Rod Kit - For St Thomas/Vitromex Tank 6203.024 LH	18.12	
	Two Piece Toilets Rod Kit	AR300302-R3	Rod Kit - For Kohler Tank 4645 RH	6.17
AR300303-L3		Rod Kit - For Kohler Tank 4645 LH	5.67	
AR300304-L3		Rod Kit - For Kohler Tank 4404 LH	5.67	
AR300305-R3		Rod Kit - For Kohler Tank 4404 RH	6.17	
AR300308-L3		Rod Kit - For Gerber 21-012 LH	8.42	
504	Two Piece Toilets Handle and Rod Kit	AP300111-L4	Handle/Rod Kit - For Lamosa/Vortens Tank 3468 LH	18.12
		AP300112-L4	Handle/Rod Kit - For Mancesa Tank 04103 LH	18.12
		AP300108-L4	Handle/Rod Kit - For Mansfield Tank 153 LH	18.12
		AP300113-L4	Handle/Rod Kit - For Niagara Tank N2310T LH	18.12
		AP300116-L4	Handle/Rod Kit - For Proflo Tank PF1612LH	18.12
		AP300117-R4	Handle/Rod Kit - For Proflo Tank PF1612RH	19.12
		AP300110-L4	Handle/Rod Kit - For Vitra Tank 5066 LH	18.12
		AP300101-L4	Handle/Rod Kit - For St Thomas/Vitromex Tank 6203.424 LH	18.12
	Two Piece Toilets Rod Kit	AR300306-L4	Rod Kit - For Kohler Tank 4484 LH	5.67
		AR300307-R4	Rod Kit - For Kohler Tank 4484-RA RH	6.17
		AR300310-L4	Rod Kit - For Peerless 1, 1.0 gpf LH	5.67
	One Piece Toilets Rod Kit	AR300309-L4C	Rod Kit - For Kohler K-3597 LH	8.42

MISCELLANEOUS PARTS AND TOOLS

PART NO.	DESCRIPTION	PRICE
ST100100	Flushmate Discharge-Nut Wrench	\$3.60
ST100200	Flushmate Tool Kit - Discharge-Nut Wrench and Cartridge Wrench	10.00
ST100500	Cartridge Wrench	8.70

PART NO.	DESCRIPTION	PRICE
E-205288	Tank-to-Bowl Gasket - For all except Mansfield	2.50
DP400999-1	Push Button - Convex	10.95

INTELLI FLUSH AUTOMATIC FLUSHING SYSTEMS

SERIES	PART NO.	DESCRIPTION	PRICE
501-B, 503, and 504*	K-100100	On-Wall Sensor with White Trim	170.63
	K-100101	On-Wall Sensor with Chrome Trim	176.14
	K-100500	Override button Only - no sensor	116.17



* Except for Mancesa or Vitromex fixtures, and push-button models.

Online Support

You can visit our website at www.flushmate.com for answers to questions you might have, additional product information or announcements on new products and promotions. 24/7 support is provided through the How to Videos topic in the Product Support Section. Also included are the following topics:

How it works
See It work
Benefits
Installation
FAQ
Toilet Models
Rebates
Document Library
Press Room
Testimonials
WaterSense
Product Support
Owner's Manuals
Where To Buy
Product/Registration
Product Advisory
About Us
Contact

Phone Support

If you need to contact Flushmate by phone, Flushmate technical service professionals are available Monday - Friday 8:00 AM - 4:30 PM EST. Have handy the information from the Flushmate label found on the vessel inside the tank.

1-800-533-3460

**TO PLACE ORDER, FAX OR
MAIL YOUR ORDER TO:
Fax: 248-446-2190
Email: sales@flushmate.com**

Flushmate Standard Terms and Conditions

Freight Terms

All shipments are F.O.B. Factory (New Hudson, Michigan), and are prepaid and charged.

Payment Terms

Cash discount 2% - 15 days net 30 days

A 2% discount is offered for payment on or before 15 days after the date of invoice with the net due 30 days from invoice date, subject to a service charge of 1% applied monthly to all late payments. Any conditions or terms of payment on purchase order which are contradictory to our cash discount offer shall be of no effect.

Remit To

Flushmate, Dept. 771273, P. O. Box 77000,
Detroit, MI 48277-1273.

Minimum Charges

On all orders having a small net value we reserve the right to apply a \$25.00 net minimum charge.

Note: The prices herein are subject to change without notice and supersede all previous prices. The possession of this price sheet by any person is not to be construed as an offer to sell him, nor anyone else, the goods listed herein at the price or terms stated.

Return Goods Authorization Policy

- A Return Goods Authorization (RGA) number must be obtained from Flushmate before returning any product.
- The RGA number must appear on all documents and packaging.
- All returns must be shipped at customers expense.
- Product found to be defective upon inspection and determination by Flushmate is eligible for replacement only; no credit will be issued.
- Unless shipped in error by Flushmate, non-defective product will be subject to a 25% restock fee.
- Credit can only be issued for product received in re-sellable condition (never installed, in original package).

Please contact us at the telephone number listed below if you are in need of an RGA request form.

Shortages and Damaged Material Claims

Claims for shortages or incorrect filling of orders or to report a damaged material must be made within 15 days from the date of delivery. No claims made beyond this date will be honored. Deliveries that are short carton(s) or have damaged carton(s) must be reported immediately. Damaged carton(s) must be kept for Carrier Claim Inspector (Recommend taking picture of damaged box upon delivery).

For support outside the United States, visit our local contact website at <https://www.flushmate.com/wheretobuy/international.php>.

Flushmate products cannot be retrofitted to existing gravity toilet bowls. Please see "Complete Change-Out Kits for Two-Piece Toilets" section for specific change-out information of Flushmate pressure toilets.



FLUSHMATE®

30075 Research Drive, New Hudson, MI 48165
Tel: (800) 533-3460 | Fax: (248) 446-2150

©2014 Flushmate.

www.flushmate.com

FLU6273.5 0414